

Table of Contents



INDUSTRIAL ROLLING LADDERS
(6-13)



STATIONARY PLATFORMS
(20-23)



MOBILE WORK PLATFORMS
(14-17)



SECURITY
(24-29)



FIXED LADDERS
(18-19)

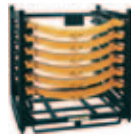

STORAGE
(30-35)

Design ~ Prototype ~ Production

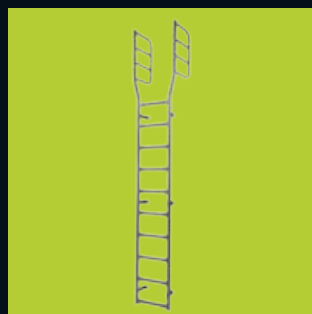

EGA Products

Designed with access in mind.

With more than 360 standard models to choose from, EGA offers 10 full ladder lines to meet your retail, warehousing and manufacturing application needs. Whether it's a dock ladder or an industrial truck ladder, every product in the EGA line is designed for optimum performance and safety at an affordable price. Whatever the application, our experts can provide the right ladder solution.

All EGA products - ladders, storage racks, carts, dollies and partitions - are made entirely in the U.S. to ensure you receive the highest quality product for years of dependable service.

STANDARD FEATURES

- Choose from steel, aluminum, or stainless construction.
- Select from Grip Strut®, EZY tread, or Anti-Slip vinyl treads for step and platform surfaces.
- Select from a variety of step widths to fit your application.
- Steel reinforced rubber feet, foot/bumper pads and super durable casters utilized.
- Floor locking systems designed and tailored for each specific style.
- Models that ship knocked-down, factory-erect (set-up), or fold-away.
- All ladders meet or exceed OSHA/ANSI standards with Cal-OSHA ladders available.
- Ability to add double or triple top steps, and fold down tray to most models.

EZY TREAD®

- Choose for standard duty or cleaner areas.
- Perforated tread design formed from a solid steel sheet.
- Eliminates sagging problems and front edge wear which are common with most expanded metal treads
- Available in steel models only.
- Self cleaning, sure footed, and economical.

GRIP STRUT®

- A must when oily or wet surfaces can be underfoot.
- A serrated tooth surface formed from a solid steel sheet.
- Acclaimed by all ladder manufacturers.
- Steel or aluminum construction.
- Aggressive, strong, sure footed and self cleaning.

RUBBER SURFACE TREADS

- Best choice if a solid tread surface is desired.
- Soft, resilient surface that will last.
- Slip-resistant textured surface for sure footing.

FLOOR LOCKING SYSTEMS

- Spring-loaded casters retract automatically under individual's weight. Durable steel reinforced rubber tips grip floor and secure ladder when in use. Steel inserts in tips provide strength and lengthen rubber tip life (A & B).
- EZY-Lock actually is a carriage providing mobility in transport, stability when in use. Minimum of moving parts assures long service life. Four casters located on the corners of the carriage/ladder provide mobile stability to the ladder. The first ladder step disengages carriage which puts ladder firmly on floor before being used. Step on one of two convenient foot pedals and the ladder is again mobile. No other ladder has a system with these safety orientated features (C & D).

Anti-Slip Vinyl Ribbed Aluminum EZY Tread® Grip Strut®



A



B



C



D

How to Select the Right Ladder for You (We Have 100's!)

1. Select platform height based on operations to be performed. Maximum convenient working height is generally 5' 0" above top platform.
2. Select as wide a ladder as space permits. Take into account whether people must pass ladder in aisle and where ladder must rest when not in use.
3. Consider limitations on ladder dimensions imposed by doorways, overhead obstructions, corners that ladder must turn, etc.
4. Consider some of our special "optional" features to insure the complete effectiveness of your EGA ladder.
5. For unusual conditions not illustrated in this brochure, we can provide custom engineering.

EXAMPLE:

WORKING HEIGHT = 160"

— **MINUS 60" (5' 0")**

≡ **EQUALS PLATFORM HEIGHT = 100"**

SINCE 10" = 1 TREAD HEIGHT

NUMBER OF STEPS = 10

How to Order

1. Select the model that best fits your application and performance requirements (see Select the Right Ladder above).
2. Review accessories and options to complete the effectiveness of your EGA Ladder. Include items on order.
3. When available, specify KD (knocked-down) if desired. Models ordered without KD option will be supplied as all-welded SU set-up.

Usage Tips for Ladders

1. Proper selection
2. Inspect before each use.
3. Follow USE suggestions.
4. If assembly required, follow instructions.
5. Follow maintenance guidelines.

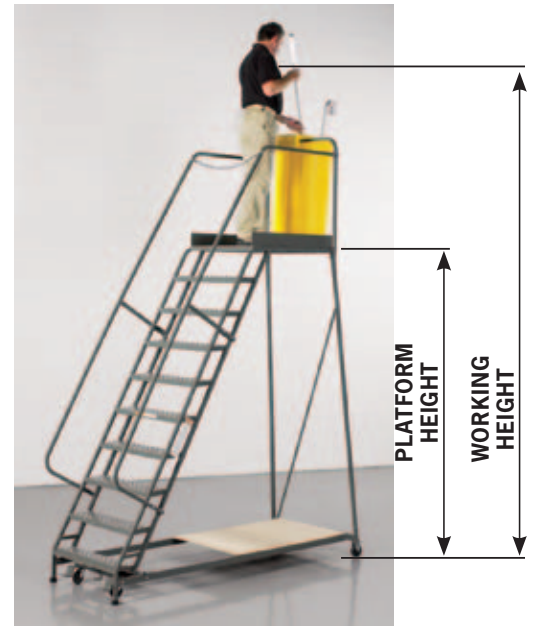

EGA Available Colors



Industrial Rolling



Office



Stockpicking



Mechanics / Maintenance



Work Platforms



Folding



Double Entry Platforms



Dual Access



Aluminum Work Platforms





Crossovers



Industrial Rolling Ladders



Square Tube

These ladders roll with ease, yet lock securely in place while in use. They are ideal for a wide variety of warehouse, stockroom, maintenance and shop floor applications. Rugged square tube construction is 40% stronger than round tubing and welded sub assemblies for extra strength. 450lb capacity. Rigid 1" square tubing. 2 – 4 Steps have spring-loaded 3" casters which provide mobility while rubber-tipped legs add traction while in use. 5 – 16 Steps have an Ezy-Lock that features 4" casters which are released putting ladder legs firmly on the floor when pressure is applied to bottom step. 16", 24", & 30" wide steps. Steps are 7" deep with a deeper 14" top step. Perforated or Grip Strut tread for slip-resistant footing. Meets OSHA standards.



		EZY Tread®		Grip Strut®					
									
2-7 STEP SAFETY LADDERS									
20" WIDE AT TOP	# Of Steps	Top Step Height	Step Width	Hand Rails	Overall W x L x H	Wt. Lbs.	EGA #	EGA #	Lead Times Days
	2	20	17	N	22x25x20	28	L001	L010	5
	2	20	17	Y	22x25x56	31	L002	L011	5
	3	30	17	N	22x34x30	34	L003	L012	5
	3	30	17	Y	22x34x66	38	L004	L013	5
	4	40	17	N	22x44x40	50	L005	L014	5
	4	40	17	Y	22x44x76	55	L006	L015	5
	5	50	17	Y	24x43x86	65	L007	L016	5
	6	60	17	Y	25x50x96	78	L008	L017	5
7	70	17	Y	27x57x106	88	L009	L018	5	

		EZY Tread®		Grip Strut®					
									
26" WIDE AT TOP	# Of Steps	Top Step Height	Step Width	Hand Rails	Overall W x L x H	Wt. Lbs.	EGA #	EGA #	Lead Times Days
	2	20	24	N	28x25x20	30	L019	L028	5
	2	20	24	Y	28x25x56	33	L020	L029	5
	3	30	24	N	28x34x30	37	L021	L030	5
	3	30	24	Y	28x34x66	41	L022	L031	5
	4	40	24	N	28x44x40	55	L023	L032	5
	4	40	24	Y	28x44x76	60	L024	L033	5
	5	50	24	Y	31x43x86	72	L025	L034	5
	6	60	24	Y	32x50x96	84	L026	L035	5
7	70	24	Y	33x57x106	100	L027	L036	5	

		EZY Tread®		Grip Strut®					
									
32" WIDE AT TOP	# Of Steps	Top Step Height	Step Width	Hand Rails	Overall W x L x H	Wt. Lbs.	EGA #	EGA #	Lead Times Days
	2	20	30	N	34x25x20	31	L037	L046	5
	2	20	30	Y	34x25x56	34	L038	L047	5
	3	30	30	N	34x34x30	38	L039	L048	5
	3	30	30	Y	34x34x66	43	L040	L049	5
	4	40	30	N	34x44x40	63	L041	L050	5
	4	40	30	Y	34x44x76	68	L042	L051	5
	5	50	30	Y	37x43x86	82	L043	L052	5
	6	60	30	Y	38x50x96	96	L044	L053	5
7	70	30	Y	39x57x106	114	L045	L054	5	



8-16 STEP							EZY Tread®	Grip Strut®	
# Of Steps	Top Step Height	Step Width	Hand Rails	Overall W x L x H	Wt. Lbs.	EGA #	EGA #	Lead Times Days	
26" WIDE AT TOP	8	80	24	Y	32x63x117	112	L055	L064	5
	9	90	24	Y	33x70x127	124	L056	L065	5
	10	100	24	Y	34x76x137	136	L057	L066	5
	11	110	24	Y	36x83x147	148	L058	L067	5
	12	120	24	Y	37x90x157	160	L059	L068	5
	13	130	24	Y	38x96x167	175	L060	L069	5
	14	140	24	Y	39x103x177	190	L061	L070	5
	15	150	24	Y	40x109x187	210	L062	L071	5
	16	160	24	Y	41x116x197	235	L063	L072	5
32" WIDE AT TOP	8	80	28	Y	38x63x117	128	L073	L082	5
	9	90	28	Y	39x70x127	142	L074	L083	5
	10	100	28	Y	40x76x137	156	L075	L084	5
	11	110	28	Y	41x83x147	170	L076	L085	5
	12	120	28	Y	42x90x157	184	L077	L086	5
	13	130	28	Y	43x96x167	201	L078	L087	5
	14	140	28	Y	45x103x177	218	L079	L088	5
	15	150	28	Y	46x109x187	240	L080	L089	5
	16	160	28	Y	47x116x197	246	L081	L090	5

* NOTE: EZY Lock bottom step standard on 5 step ladders and above.

Shipping Info

Starting Zip	Freight Class
53005	All Steps 150 to 250

360 Degree Rotating Rolling Ladders

Square Tube

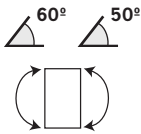

EGA 360 degree rotating rolling ladders are the perfect solution for tight warehouse aisles. These ladders can spind on their own axis while still being able to track in a straight line. Unique 4 wheel, double Ezy-lock design. 2-1/2" pads on each ladder leg for secure feel in the climbing position. Rugged 1" square tube construction with comfortable 1" round tube hand rails. Available in 60 degree incline angle for a more compact foot print or ezy-angle 50 degree incline. Meets OSHA standards. Weight capacity is 450 lbs.



Starting Zip	Freight Class
53005	All Steps 150 to 250

60 DEGREE INCLINE 360 DEGREE ROTATING LADDER



	# Of Steps	Top Step height	Step Width	Hand Rails	Overall W x L x H	Wt. Lbs.	EZY Tread®	Grip Strut®	Lead Times Days
							EGA #	EGA #	
26" W AT TOP	7	70	24	Y	31x57x106	183	K001	K101	10
	8	80	24	Y	33x63x116	198	K002	K102	10
	9	90	24	Y	34x70x126	212	K003	K103	10
	10	100	24	Y	35x76x136	227	K004	K104	10
	11	110	24	Y	36x83x146	269	K005	K105	10
	12	120	24	Y	37x90x162	284	K006	K106	10
	13	130	24	Y	38x96x172	299	K007	K107	10
	14	140	24	Y	39x103x182	313	K008	K108	10
	15	150	24	Y	40x109x192	328	K009	K109	10
	16	160	24	Y	42x116x202	342	K010	K110	10

32" W AT TOP	7	70	30	Y	37x57x106	198	K011	K111	10
	8	80	30	Y	38x63x116	218	K012	K112	10
	9	90	30	Y	39x70x126	234	K013	K113	10
	10	100	30	Y	40x76x136	246	K014	K114	10
	11	110	30	Y	41x83x146	291	K015	K115	10
	12	120	30	Y	42x90x162	307	K016	K116	10
	13	130	30	Y	43x96x172	324	K017	K117	10
	14	140	30	Y	44x103x182	340	K018	K118	10
	15	150	30	Y	46x109x192	356	K019	K119	10
	16	160	30	Y	47x116x202	372	K020	K120	10

50 DEGREE INCLINE 360 DEGREE ROTATING LADDER



	# Of Steps	Top Step height	Step Width	Hand Rails	Overall W x L x H	Wt. Lbs.	EZY Tread®	Grip Strut®	Lead Times Days
							EGA #	EGA #	
26" W AT TOP	7	70	24	Y	31x73x106	154	K201	K301	10
	8	80	24	Y	33x82x116	177	K202	K302	10
	9	90	24	Y	34x91x126	193	K203	K303	10
	10	100	24	Y	35x100x136	209	K204	K304	10
	11	110	24	Y	35x109x146	225	K205	K305	10
	12	120	24	Y	37x118x162	241	K206	K306	10

32" W AT TOP	7	70	30	Y	37x73x106	172	K211	K311	10
	8	80	30	Y	38x82x116	194	K212	K312	10
	9	90	30	Y	39x91x126	212	K213	K313	10
	10	100	30	Y	40x100x136	230	K214	K314	10
	11	110	30	Y	41x109x146	248	K215	K315	10
	12	120	30	Y	42x118x162	266	K216	K316	10

Multi-directional Rolling Ladders

Square Tube

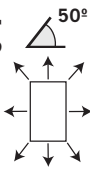

EGA multi-directional rolling ladders have four swivel casters which allows precision steering - enabling easier positioning of ladder in tight areas. Double Ezy-Lock mechanism easily lifts ladder to the rolling position. Stepping on the bottom step secures ladder to floor with large 2-1/2" diameter pads on each leg. 50 degree incline safety angle on stair makes ascending/descending more comfortable and with less effort. Tough 1" square tube construction with ergonomic round tube handrails. Weight capacity is 450lbs. Meets OSHA standards



J013

50 DEGREE INCLINE MULTI-DIRECTIONAL ROLLING LADDER

EZY Tread®

Grip Strut®



	# Of Steps	Top Step height	Step Width	Hand Rails	Overall W x L x H	Wt. Lbs.	EGA #	EGA #	Lead Times Days
19" W AT TOP	5	50	17	Y	24x54x86	120	J001	J101	10
	6	60	17	Y	26x64x96	134	J002	J102	10
	7	70	17	Y	27x73x106	148	J003	J103	10

26" W AT TOP	5	50	24	Y	31x54x86	133	J011	J111	10
	6	60	24	Y	32x64x96	149	J012	J112	10
	7	70	24	Y	33x73x106	165	J013	J113	10
	8	80	24	Y	35x82x116	188	J014	J114	10
	9	90	24	Y	36x91x126	204	J015	J115	10
	10	100	24	Y	37x100x136	220	J016	J116	10
	11	110	24	Y	38x109x146	236	J017	J117	10
	12	120	24	Y	39x119x162	252	J018	J118	10

32" W AT TOP	5	50	30	Y	37x54x86	148	J021	J121	10
	6	60	30	Y	38x64x96	166	J022	J122	10
	7	70	30	Y	39x73x106	183	J023	J123	10
	8	80	30	Y	40x82x116	205	J024	J124	10
	9	90	30	Y	41x91x126	223	J025	J125	10
	10	100	30	Y	42x100x136	241	J026	J126	10
	11	110	30	Y	44x109x146	259	J027	J127	10
	12	120	30	Y	45x119x162	277	J028	J128	10

Shipping Info

Starting Zip	Freight Class
53005	All Steps 150 to 250

□ EZY Climb

Unlike other steeper industrial warehouse ladders, the safety angle is designed with a more gradual incline for the feel and comfort of a stairway. Incorporating a deeper run, it allows workers to easily carry stock items while ascending/descending more quickly. 450 lbs capacity. Rigid 1" square tubing. 2 - 4 steps: Spring loaded 3" casters provide mobility while rubber tipped legs adds traction while in use. 5 - 10 steps: Ezy-Locks features 4" casters, which are released putting ladder legs firmly on the floor when pressure is applied to bottom step. 16", 24" & 30" wide steps available. Steps are 7" deep with a deeper 14" top step. Perforated or Grip Strut Tread for slip-resistant footing. Meets OSHA standards.

Z004



EZY ANGLE SAFETY LADDERS



	# Of Steps	Top Step height	Step Width	Hand Rails	Overall W x L x H	Wt. Lbs.	EZY Tread®	Grip Strut®	Lead Times Days
							EGA #	EGA #	
20" W AT TOP	2	20	17	N	22x25x20	25	Z001	Z010	5
	2	20	17	Y	22x25x56	36	Z002	Z011	5
	3	30	17	N	22x34x30	38	Z003	Z012	5
	3	30	17	Y	22x34x66	40	Z004	Z013	5
	4	40	17	N	22x44x40	42	Z005	Z014	5
	4	40	17	Y	22x44x76	60	Z006	Z015	5
	5	50	17	Y	22x54x86	71	Z007	Z016	5
	6	60	17	Y	23x63x96	86	Z008	Z017	5
	7	70	17	Y	24x72x106	95	Z009	Z018	5



	# Of Steps	Top Step height	Step Width	Hand Rails	Overall W x L x H	Wt. Lbs.	EZY Tread®	Grip Strut®	Lead Times Days
							EGA #	EGA #	
26" W AT TOP	2	20	24	N	25x28x20	29	Z019	Z028	5
	2	20	24	Y	25x28x56	38	Z020	Z029	5
	3	30	24	N	28x34x30	40	Z021	Z030	5
	3	30	24	Y	28x34x66	42	Z022	Z031	5
	4	40	24	N	28x44x40	44	Z023	Z032	5
	4	40	24	Y	28x44x76	62	Z024	Z033	5
	5	50	24	Y	29x54x86	76	Z025	Z034	5
	6	60	24	Y	30x63x96	90	Z026	Z035	5
	7	70	24	Y	31x72x106	102	Z027	Z036	5

Shipping Info

Starting Zip	Freight Class
53005	All Steps 150 to 250





Z052



	# Of Steps	Top Step Height	Step Width	Hand Rails	Overall W x L x H	Wt. Lbs.	EZY Tread®	Grip Strut®	Lead Times Days
							EGA #	EGA #	
32" WIDE AT TOP	2	20	30	N	25X34X20	31	Z037	Z046	5
	2	20	30	Y	25X34X56	40	Z038	Z047	5
	3	30	30	N	34X34X30	42	Z039	Z048	5
	3	30	30	Y	34X34X66	44	Z040	Z049	5
	4	40	30	N	34X44X40	41	Z041	Z050	5
	4	40	30	Y	34X44X76	69	Z042	Z051	5
	5	50	30	Y	34X54X86	84	Z043	Z052	5
	6	60	30	Y	35X63X96	96	Z044	Z053	5
	7	70	30	Y	37X72X106	110	Z045	Z054	5

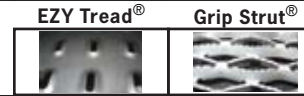

	# Of Steps	Top Step Height	Step Width	Hand Rails	Overall W x L x H	Wt. Lbs.	EZY Tread®	Grip Strut®	Lead Times Days
							EGA #	EGA #	
26-32" WIDE AT TOP	8	80	24	Y	32X81X116	120	Z055	Z058	5
	9	90	24	Y	33X91X126	135	Z056	Z059	5
	10	100	24	Y	34X100X136	150	Z057	Z060	5
	8	80	30	Y	38X81X116	130	Z061	Z064	5
	9	90	30	Y	39X91X126	140	Z062	Z065	5
	10	100	30	Y	40X100X136	160	Z063	Z066	5

* NOTE: EZY Lock bottom step standard on 5 step ladders and above.

Shipping Info

Starting Zip	Freight Class
53005	All Steps 150 to 250

Office Ladders ^{60°}

Built with 100% square tube framework for a clean look, Office Ladders come in four standard colors to match your office decor. 450lb capacity. Rigid 1" square tubing. Spring-loaded 3" casters provide mobility while rubber-tipped legs add traction while in use. 16" and 24" wide steps available. Steps are 7" deep with a deeper 14" top step. Steps are coated with anti-slip vinyl. Solid treads coated with anti-slip vinyl. Meets OSHA standards.

Anti-Slip Vinyl



# Of Steps	Top Step Height	Step Width	Hand Rails	Overall W x L x H	Wt. Lbs.	EGA #	Lead Times Days
1	10	16	N	22x20x10	21	F001	5
2	20	16	N	22x23x20	29	F002	5
2	20	16	Y	22x23x44	37	F003	5
3	30	16	N	22x27x30	37	F004	5
3	30	16	Y	22x29x54	45	F005	5
4	40	16	N	22x35x40	51	F006	5
4	40	16	Y	22x36x64	61	F007	5
5	50	16	Y	23x50x80	77	F008	5
6	60	24	Y	32x57x90	82	F009	5



F005-A

Shipping Info

Starting Zip	Freight Class
53005	1-4 Steps 150 to 250
53005	5-6 Steps 300 to 400

Industrial Rolling Ladders



EZY Tread®

Grip Strut®



Round Tube

Industrial-grade ROLL-EZY ladders are constructed of durable, welded steel and are suited to a wide variety of stockroom, warehouse, maintenance and shop floor applications. These ladders are available standard with your choice of EZY tread. Grip Strut® or Anti-Slip Vinyl surface tread. Ideal for general industrial use, stock picking, and maintenance needs.

FEATURES

1. 450 lbs. (1 person) capacity.
2. Rigid 1" diameter steel tubular frame designed for strength and security
3. Standard widths available for most models are 16", 24" and 30".
4. Steps are 7" deep with the top step 9½" deep.
5. 3" spring-loaded casters provide portability while rubber tips hold ladder in place during use (1-7 steps standard).
6. EZY-Lock provides mobility and holds ladder in place during use (8-16 steps standard). Also standard on 6020H, 7020H plus 6 and 7 steps with deep top step.
7. KD models incorporate a steel sleeve and pin joint connection secured by a set screw with nyloc patch which provide four-fold safety.



# Of Steps	Top Step Height	Step Width	Overall W x L x H	Wt. Lb.	EGA #	EGA #	Lead Times Days
1	12"	16"	20x16x12	13	B1220SU+	G1220SU+	5
1	12"	24"	27x16x12	16	B1226SU+	G1226SU+	5
2	20"	16"	21x19x20	22	B2020SU+	G2020SU+	5
2	20"	24"	27x19x20	26	B2026SU+	G2026SU+	5
2	20"	16"	21x19x44	29	B2020HSU+	G2020HSU+	5
2	20"	24"	27x19x44	34	B2026HSU	G2026HSU	5
3	30"	16"	21x27x30	33	B3020SU+	G3020SU+	5
3	30"	24"	29x27x30	39	B3026SU	G3026SU	5
3	30"	16"	21x28x54	41	B3020HSU+	G3020HSU+	5
3	30"	24"	29x27x54	48	B3026HSU	G3026HSU	5
4	40"	16"	21x36x40	42	B4020SU	G4020SU	5
4	40"	24"	29x36x40	51	B4026SU	G4026SU	5
4	40"	30"	33x36x40	58	B4032SU	G4032SU	5
4	40"	16"	21x33x70	51	B4020HSU	G4020HSU	5
4	40"	24"	29x33x70	64	B4026HSU	G4026HSU	5
4	40"	30"	33x33x70	73	B4032HSU	G4032HSU	5
5	50"	16"	21x40x80	64	B5020HSU	G5020HSU	5
5	50"	24"	29x40x80	76	B5026HSU	G5026HSU	5
5	50"	30"	33x40x80	84	B5032HSU	G5032HSU	5
6	60"	16"	23x44x90	80	B6020HSU	G6020HSU	5
6	60"	24"	29x47x90	82	B6026HSU	G6026HSU	5
6	60"	30"	33x47x90	102	B6032HSU	G6032HSU	5
7	70"	16"	24x52x100	89	B7020HSU	G7020HSU	5
7	70"	24"	29x54x100	104	B7026HSU	G7026HSU	5
7	70"	30"	33x54x100	116	B7032HSU	G7032HSU	5
8	80"	24"	33x56x112	154	B8026HSU	G8026HSU	5
8	80"	30"	38x56x112	174	B8032HSU	G8032HSU	5
9	90"	24"	33x63x122	179	B9026HSU	G9026HSU	5
9	90"	30"	38x63x122	193	B9032HSU	G9032HSU	5
10	100"	24"	33x69x132	207	B10026HSU	G10026HSU	5
10	100"	30"	38x69x132	222	B10032HSU	G10032HSU	5
11	111"	24"	33x75x142	228	B11026HSU	G11026HSU	5
11	111"	30"	38x75x142	245	B11032HSU	G11032HSU	5
12	112"	24"	33x82x157	241	B12026HSU	G12026HSU	5
12	112"	30"	38x82x157	259	B12032HSU	G12032HSU	5

(+) UPS Shippable - Add \$8.50 WI only.

Shipping Info

Starting Zip	Freight Class
53005 or 28115	2 - 4 Steps 150 to 250
53005 or 28115	5 - 12 Step 300 to 400



KNOCKED DOWN					EZY Tread®	Grip Strut®	
# Of Steps	Top Step Height	Step Width	Overall W x L x H	Wt. Lb.	EGA #	EGA #	Lead Times Days
5	50"	16"	21x40x80	64	B5020HKD	G5020HKD	5
5	50"	24"	29x40x80	76	B5026HKD	G5026HKD	5
5	50"	30"	33x40x80	84	B5032HKD	G5032HKD	5
6	60"	16"	23x44x90	80	B6020HKD	G6020HKD	5
6	60"	24"	29x47x90	91	B6026HKD	G6026HKD	5
6	60"	30"	33x47x90	102	B6032HKD	G6032HKD	5
7	70"	16"	24x52x100	89	B7020HKD	G7020HKD	5
7	70"	24"	29x54x100	104	B7026HKD	G7026HKD	5
7	70"	30"	33x54x100	116	B7032HKD	G7032HKD	5
8	80"	24"	33x56x112	154	B8026HKD	G8026HKD	5
8	80"	30"	38x56x112	174	B8032HKD	G8032HKD	5
9	90"	24"	33x63x122	179	B9026HKD	G9026HKD	5
9	90"	30"	38x63x122	193	B9032HKD	G9032HKD	5
10	100"	24"	33x69x132	207	B10026HKD	G10026HKD	5
10	100"	30"	38x69x132	222	B10032HKD	G10032HKD	5
11	110"	24"	33x75x142	228	B11026HKD	G11026HKD	5
11	110"	30"	38x75x142	215	B11032HKD	G11032HKD	5
12	120"	24"	33x82x157	241	B12026HKD	G12026HKD	5
12	120"	30"	38x82x157	287	B12032HKD	G12032HKD	5
13	130"	24"	34x88x167	259	B13026HKD#	G13026HKD#	10
13	130"	30"	39x88x167	298	B13032HKD#	G13032HKD#	10
14	140"	24"	37x94x177	299	B14026HKD#	G14026HKD#	10
14	140"	30"	39x94x177	311	B14032HKD#	G14032HKD#	10
15	150"	24"	39x104x187	345	B15026HKD#	G15026HKD#	10
15	150"	30"	39x104x187	359	B15032HKD#	G15032HKD#	10
16	160"	24"	41x113x197	394	B16026HKD#	G16026HKD#	10
16	160"	30"	41x113x197	406	B16032HKD#	G16032HKD#	10

(#) Welded; split horizontality (Ships Class 300).

* NOTE: EZY Lock bottom step begins at 8 step ladders and above.
Also, 7 step, 20" wide; and double and triple top step 6 and 7 step ladders.

Casters	
1 to 7 steps	3" ball bearing swivel
8 to 16 steps	4" ball bearing swivel and 4" rigid on rear

Freight Class	
150	For all 1-4 step and KD models 5-12 step DTS
300	For all set-up models 5-12 step and KD models 12 step TTS-16 step



Industrial Truck Ladder

Finally, a ladder that provides secure, safer access to semi-trailers when docking bays are full or unavailable. Ideal for retail and stand alone facilities, this ladder offers the “trailer jumpers” a safer alternative. The Industrial Truck Ladder has a 55-degree angle and provides a deeper run which allows workers to ascend/descend more quickly. Rugged, 10-inch semi-pneumatic wheels enable easy transport over rough surfaces - just lift the front bumpers and go.

Features

- 450 lbs. (1 person) capacity.
- Rigid 1" diameter all welded steel tubular frame.
- 10" rear wheels roll easily over the toughest surfaces (e.g., bar grating).
- 2 1/2 " heavy duty rubber bumpers/pads on front legs holds ladder secure during use.
- Steps are 36" W x 7" D.
- Top step is 36" W x 19" D.
- Top step height of 47 1/2" allows access to standard semi-trailers.
- Grip Strut® tread provides sure footing and self cleaning on steps.
- Safety chain at both the top and bottom of ladder for added safety.

Plus

- Ladder can be moved in no time with a simple lift and go.
- All-welded construction for the toughest industrial use.
- Meets OSHA standards.
- Gray enamel finish standard.



Grip Strut®



# Of Steps	Hand Rails	Top Step Height	OA Height	Base W x L	Weight Lbs.	Grip Strut® Model
5	Y	47 1/2	72 1/2	45 x 51	135	TG4838H

Shipping Info: Wisconsin or NC

Starting Zip	Freight Class	Lead Time
53005	300	10 Days
28115	300	10 Days

□ Stockpicking Ladders ^{50°}

This versatile ladder can be used as a combination ladder as well as a carrying cart/stock-picker. It allows multiple items to be pulled from stock at the same time, reducing your response times. 450lb capacity. Rigid 1" square tubing. Ezy-Lock features 4" casters which are released putting ladder legs firmly on the floor when pressure is applied to bottom step. 24" wide steps. Steps are 7" deep with a deeper 21" top step. Perforated or Grip Strut tread for slip-resistant footing. Shelves are 23" x 25". Meets OSHA standards.

EZY Tread®

Grip Strut®



# Of Steps	Top Step Height	Step Width	Hand Rails	Overall W x L x H	Weight Lbs.	EGA #	EGA #	Lead Times Days
6	60	24	Y	30x70x97	175	P001	P007	14
7	70	24	Y	31x79x107	185	P002	P008	14
8	80	24	Y	32x88x117	195	P003	P009	14
9	90	24	Y	33x98x127	205	P004	P010	14
10	100	24	Y	34x107x137	210	P005	P011	14
11	110	24	Y	36x116x147	230	P006	P012	14



P003

Shipping Info

Starting Zip	Freight Class
53005	All Steps 300-400

□ Mechanics / Maintenance Ladders

Ideal for a variety of applications around the production or shop floor. A 21" deep top platform with a detachable chain at rear allows full access to work areas. Plus convenient handles at ladder front allow instant mobility. Perfect for the worker on the go. Rigid 1" square tubing. 4" casters provide mobility and rubber-tipped legs add traction while in use. 24" wide steps. Steps are 7" deep with a deeper 21" step at top. Perforated or Grip Strut tread for slip-resistant footing. Meets OSHA standards. 450lb weight capacity.

# Of Steps	Top Step Height	Step Width	Hand Rails	Overall W x L x H	Wt. Lbs.	Tread Options		Lead Times Days
						EZY Tread®	Grip Strut®	
						EGA #	EGA #	
4	40	24	Y	28x49x70	63	M001	M005	10
5	50	24	Y	29x55x80	78	M002	M006	10
6	60	24	Y	30x62x90	88	M003	M007	10
7	70	24	Y	31x69x100	101	M004	M008	10



Shipping Info

Starting Zip	Freight Class
53005	All Steps 150 to 250

□ Folding Ladders

Designed to fold into a convenient, compact package for storage and transport with just 4 screws and still perform in the toughest industrial situations. The ladder tilts on large, 10" diameter wheels to pass underneath overhead obstacles or through doorways. 16" wide steps. Steps are 7" deep with a deeper 14" top step. Perforated or Grip Strut tread for slip-resistant footing. Meets OSHA standards. 450lb weight capacity.

# Of Steps	Top Step Height	Step Width	Hand Rails	Overall W x L x H	Wt. Lbs.	Tread Options		Lead Times Days
						EZY Tread®	Grip Strut®	
						EGA #	EGA #	
5	50	16	Y	28x46x87	90	S001	S009	10
6	60	16	Y	29x53x99	110	S002	S010	10
7	70	16	Y	30x59x107	125	S003	S011	10
8	80	16	Y	31x66x117	135	S004	S012	10
9	90	16	Y	32x72x127	140	S005	S013	10
10	100	16	Y	33x79x137	160	S006	S014	10
11	110	16	Y	34x86x147	185	S007	S015	10
12	120	16	Y	36x92x157	205	S008	S016	10





Shipping Info

Starting Zip	Freight Class
53005	All Steps 150 to 250

□ Mobile Work Platforms

Platforms provide a secure, movable work space at a variety of heights above floor level. 500lb capacity. Rigid 1" square tubing. 4" rear casters provide mobility and rubber-tipped legs add traction while in use. Steps are 7" deep. Perforated or Grip Strut tread for slip-resistant footing. Meets OSHA standards.

						EZY Tread®	Grip Strut®		
									
	# of Steps	Step Width	Platform W x D x H	Base W x L	Wt. Lbs.	EGA #	EGA #	Lead Times	Days
WITHOUT HANDRAIL	3	24	24x35x30	27x49	75	W025	W033	10	
	3	24	24x49x30	27x64	86	W026	W034	10	
	3	30	30x35x30	32x49	88	W027	W035	10	
	3	30	30x49x30	32x64	100	W028	W036	10	
	4	24	24x35x40	27x55	90	W029	W037	10	
	4	24	24x49x40	27x69	101	W030	W038	10	
	4	30	30x35x40	32x55	103	W031	W039	10	
	4	30	30x49x40	32x69	116	W032	W040	10	
32" Optional Handrail for Above Models						W050		10	
WITH RAIL	5	24	24x35x50	27x61	106	W041	W045	10	
	5	24	24x49x50	27x75	117	W042	W046	10	
	5	30	30x35x50	32x61	119	W043	W047	10	
	5	30	30x49x50	32x75	132	W044	W048	10	





Shipping Info

Starting Zip	Freight Class
53005 or 28115	300

□ Mobile Aluminum Work Platforms

Lightweight platform provides a stable and solid work surface that is both weather and corrosion resistant. 300lb capacity. Rigid 1" square tubing. 4" Rear Tilt Back casters provide mobility and rubber-tipped legs add traction while in use. Solid Ribbed Extruded step or Grip Strut tread for slip-resistant footing. Meets OSHA standards.

						Aluminum Ribbed Channel	Grip Strut®		
									
	# Of Steps	Step Width	Platform W x D x H	Base W x L	Wt. Lbs.	EGA #	EGA #	Lead Times	Days
	2	24	24x35x20	27x47	38	A001	A010	10	
	2	24	24x42x20	27x54	42	A002	A011	10	
	2	24	24x49x20	27x61	45	A003	A012	10	
	3	24	24x35x30	27x53	48	A004	A013	10	
	3	24	24x42x30	27x60	51	A005	A014	10	
	3	24	24x49x30	27x67	55	A006	A015	10	
	4	24	24x35x40	27x59	57	A007	A016	10	
	4	24	24x42x40	27x66	60	A008	A017	10	
	4	24	24x49x40	27x73	64	A009	A018	10	
30" Optional handrail for Above Models						A019			



Shipping Info

Starting Zip	Freight Class
53005	All Stairways 300

* NOTE: All aluminum products designed by EGA are designed for function and normal use for industrial applications. Mill finish is standard.

□ Crossovers $\triangle 60^\circ$

Crossover halves simply bolt together for assembly. 300lb capacity. Rigid 1" square tubing. 24" wide steps. Steps are 7" deep with a deeper 21", 28" or 35" platform at top. Perforated or Grip Strut tread for slip-resistant footing. Meets OSHA standards.



# Of Steps	Step Width	Clearance W x H	W x L x H	Wt. Lbs.	EGA #	EGA #	Lead Times Days
4	24	22x37	29x76x70	84	C001	C010	20
4	24	29x37	29x84x70	89	C002	C011	20
4	24	36x37	29x91x70	96	C003	C012	20
5	24	22x47	29x88x80	145	C004	C013	20
5	24	29x47	29x95x80	151	C005	C014	20
5	24	36x47	29x102x80	160	C006	C015	20
6	24	22x57	29x100x90	180	C007	C016	20
6	24	29x57	29x107x90	186	C008	C017	20
6	24	36x57	29x114x90	199	C009	C018	20

Shipping Info

Starting Zip	Freight Class
53005	150-300

□ Dual Access Mobile Platforms $\triangle 60^\circ$

Platforms provide movable work surface accessible from either side. Rigid 1" square tubing. Each end has an Ezy-Lock that features 4" casters which are released putting ladder legs firmly on the floor when pressure is applied to bottom step. Steps are 7" deep with a deeper 49" platform. Handrail on (1) side only. Grip Strut tread for slip-resistant footing. Meets OSHA standards. 300lb weight capacity.



# of Steps	Step Width	Platform W x D x H	Overall W x L x H	Wt. Lbs.	EGA #	Lead Times Days
3	24	24x50x30	27x75x60	198	D001	10
4	24	24x50x40	27x86x70	225	D004	10
5	24	24x50x50	27x98x80	252	D007	10

Shipping Info

Starting Zip	Freight Class
53005	150-300

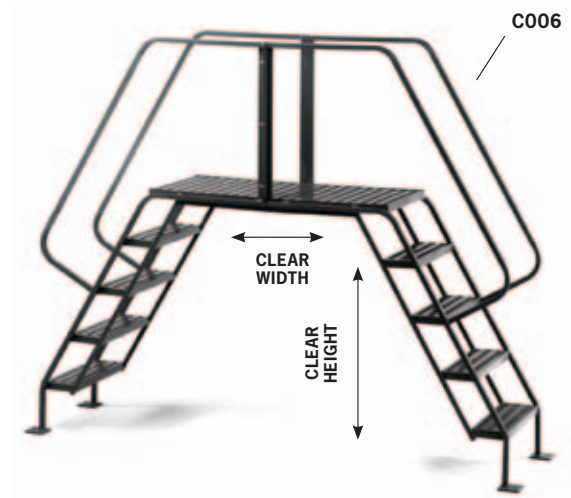

□ Double Entry Platforms $\triangle 60^\circ$

With access from either side, these mobile platforms are perfect for narrow aisles or congested areas. 300lb. capacity. Rigid 1" square tubing. Spring-loaded 3" casters provide mobility while rubber-tipped legs add traction while in use. Steps are 7" deep with a deeper 21" platform at top. Perforated Tread for slip-resistant footing. Meets OSHA standards.

EZY Tread®



# of Steps	Rails	Step Width	Platform W x D x H	Base W x L	Wt. Lbs.	EGA #	Lead Times Days
3	N	16	16x21x30	22x46	45	E001	10
3	Y	16	16x21x30	22x46	53	E002	10
4	Y	16	16x21x40	22x57	70	E003	10
5	Y	16	16x21x50	22x69	95	E004	10

Shipping Info

Starting Zip	Freight Class
53005	300-400



INDUSTRIAL ROLLING LADDER

MOBILE WORK PLATFORMS

FIXED LADDERS

STATIONARY PLATFORMS

SECURITY STORAGE



○ Aluminum Rolling Ladders △ 60°

Constructed of lightweight, all-welded aluminum alloy tubing, these ladders provide the same high performance as our other rolling ladders without the extra weight. 300lb capacity. Rigid 1" diameter tubing. Spring-loaded 3" casters provide mobility while rubber-tipped legs add traction while in use. 16" and 24" wide steps available. Steps are 7" deep with a deeper 14" top step. Extruded solid ribbed aluminum tread. Meets OSHA standards.

Aluminum Ribbed Channel



	# Of Steps	Top Step Height	Step Width	Hand Rails	Overall W x L x H	Wt. Lbs.	EGA #	Lead Times Days
20" WIDE AT TOP	2	20	17	N	20x18x20	15	A2020	10
	2	20	17	Y	20x18x44	18	A2020H	10
	3	30	17	N	20x26x30	20	A3020	10
	3	30	17	Y	20x26x54	23	A3020H	10
	4	40	17	N	20x32x40	24	A4020	10
	4	40	17	Y	20x32x70	28	A4020H	10
	5	50	17	Y	20x39x80	34	A5020H	10

Aluminum Ribbed Channel



	# Of Steps	Top Step Height	Step Width	Hand Rails	Overall W x L x H	Wt. Lbs.	EGA #	Lead Times Days
24" WIDE AT TOP	2	20	22	N	28x18x20	20	A2026	10
	2	20	22	Y	28x18x44	23	A2026H	10
	3	30	22	N	28x29x30	26	A3026	10
	3	30	22	Y	28x29x54	29	A3026H	10
	4	40	22	N	28x32x40	32	A4026	10
	4	40	22	Y	28x32x70	36	A4026H	10
	5	50	22	Y	28x39x80	43	A5026H	10
	6	60	22	Y	28x46x90	49	A6026H	10
	7	70	22	Y	28x53x100	55	A7026H	10

* NOTE: All aluminum products designed by EGA are designed for function and normal use for industrial applications. Mill finish is standard.

* NOTE: Grip Strut Adder available at \$10.00 per tread.

Shipping Info

Starting Zip	Freight Class
53005	2-4 Steps 150 to 250
53005	5-12 Steps 300 to 400

A4026



A7026H



Ladder Replacement Parts Casters Kits

EGA #	Description
CK2Y	Replacement 2" caster, rubber tips, Yellow springs & hardware (set of 4/older models 12/95 & earlier)
CK2S	Replacement 2" caster, rubber tips, Silver springs & hardware (set of 4/older models 12/95 & earlier)
CK2B	Replacement 2" caster, rubber tips, Black springs & hardware (set of 4/older models 12/95 & earlier)
CK2U	Replacement 2" caster, rubber tips, Uncoated springs & hardware (set of 4/older models 12/95 & earlier)
CK3Y	Replacement 3" casters, rubber tips, Yellow springs & hardware
CK3S	Replacement 3" casters, rubber tips, Silver springs & hardware
CK3B	Replacement 3" casters, rubber tips, Black springs & hardware
CK3U	Replacement 3" casters, rubber tips, Uncoated springs & hardware
CK4M-P	Replacement 4" casters (set of 4, 2, plate and 2 rigid fork casters)
CK4M-S	Replacement 4" casters (set of 4, 2, stem and 2 rigid fork casters)
CK4D	Replacement 4" casters (set of 4 swivel plate casters), with 2 1/2" bumpers (set of 4) & hdwe.

Ladder Replacement Parts

EGA #	Description
Y-SPRING	Replacement Yellow springs (set of 4)
S-SPRING	Replacement Silver springs (set of 4)
B-SPRING	Replacement Black springs (set of 4)
U-SPRING	Replacement Uncoated springs (set of 4)
RBUSH	Set of 4 bushings (stem caster inserts)
RSCCKTS	Replacement sockets (set of 4 stem casters)
RUBTS-R	Replacement rubber tips (set of 4 round tips)
RUBTS-S	Replacement rubber tips (set of 4 square tips)
RUBPD	Replacement rubber pads 2 1/2" diameter (pair with hardware)
R10	Replacement 10" wheels (pair)
ELS	EZY-Lock Spring (each)
W4	Replacement 4" wheels (no rigs) & hardware
BS	Bottom step assembly
NMRUBPD	Non-Marking Pads (Pair)

Work Platform Caster Kit

EGA #	Description
CK4WP	Work Platform 4" casters (set of 2 rigid)

EZY Tread® Grip Strut®



Accessories

	EGA #	Description	# of Step	# of Step
ROUND TUBE	DTS	Double top step (19" deep)	1-7	1-7
			8-11	8-11
			12-16	12-16
	TTS	Triple top step (29" deep)	1-7	1-7
			8-11	8-11
			12-16	12-16
SQUARE TUBE	21TS	Top Step (21" Deep)	1-7	1-7
			8-11	8-11
			12-16	12-16
	28ts	Top Step (28" deep)	1-7	1-7
			8-11	8-11
			12-16	12-16
35TS	Top Step (35" deep)	1-7	1-7	
		8-11	8-11	
		12-16	12-16	

EGA #	Description
FDT	Fold down tray (12" deep)
EL	EZY-Lock (39" base length req'd)
RT	Rubber covered tread
RR	Removable chain on Side* +
RC	Removable chain on Rear*
PT	Perimeter toe plate on top step*
NM	Non-marking casters**

* Add additional 5 days to lead time

** Not available on spring loaded ladders

+ 21" TS required for square tube ladders

+ DTS required for round tube ladders

Fixed Dock Ladders

Built with tough, all-weld construction for years of service, Walk-Thru and Side Step ladders provide easier access to docks, platforms and mezzanines. The Walk-Thru model features a handrail extending 42" above the top rung to help guide you safely up and down. The Side Step has 4 ladder rungs at the top for easy movement up and down. Both ladders rest 6" away from mounting surface for foot clearance when climbing. 300lb capacity. Rigid 1" diameter tubing for handrails. 19" wide steps. One-diamond Grip Strut tread for slip-resistant footing. Meets OSHA standards.

DS LADDER	# Of Steps	# Of Steps & Rungs	Overall Length	Wt. Lbs.	EGA #	Lead Times Days
	2	6	5' 6"	43	DS2	5
	3	7	6' 6"	46	DS3	5
	4	8	7' 6"	53	DS4	5
	5	9	8' 6"	58	DS5	5
	6	10	9' 6"	66	DS6	5
	7	11	10' 6"	71	DS7	5
	8	12	11' 6"	76	DS8	5
	9	13	12' 6"	80	DS9	5
	10	14	13' 6"	86	DS10	5

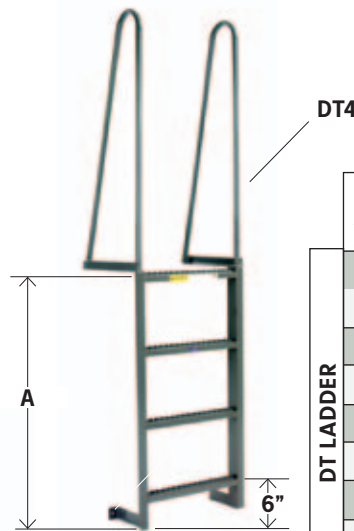

DT LADDER	# Of Steps	A Dim. Top Step Height	Wt. Lbs.	EGA #	Lead Times Days
	2	1' 6"	43	DT2	5
	3	2' 6"	46	DT3	5
	4	3' 6"	53	DT4	5
	5	4' 6"	58	DT5	5
	6	5' 6"	66	DT6	5
	7	6' 6"	71	DT7	5
	8	7' 6"	76	DT8	5
	9	8' 6"	80	DT9	5
	10	9' 6"	86	DT10	5

Shipping Info

Starting Zip	Freight Class
53005 or 28115	All Steps 70 to 85

Wall-Mount Walk-through Steel Dock Ladder

- *500 lbs. rated capacity
- *Meets OSHA requirements

Our highest weight capacity dock ladder. All welded 1-1/16 steel tube construction. Durable Yellow powder coated. Rungs are 18" wide. Hand rails continue 42" beyond top rung and are capped with red vinyl hand grip. 8" for toe clearance. Mounting brackets have 3/8" mounting hole. (Fastening hardware not included)



WALL-MOUNT WALK-THROUGH STEEL DOCK LADDER	# Of Rungs	Rung Height	Overall Length	Wt. Lbs.	EGA #	Lead Times Days
	3	2'2"	5'8"	27	RT-3	5
	4	3'2"	6'8"	31	RT-4	5
	5	4'2"	7'8"	36	RT-5	5
	6	5'2"	8'8"	43	RT-6	5
	7	6'2"	9'8"	47	RT-7	5
	8	7'2"	10'8"	52	RT-8	5
	9	8'2"	11'8"	56	RT-9	5
	10	9'2"	12'8"	64	RT-10	5

Two Step Wall-Mount Ladder

- *Grip Strut Treads
- *Meets OSHA requirements

All welded steel construction. Treads are 18" wide grip strut for traction and self-cleaning. Better for slippery or wet conditions. Four mounting holes for secure fastening to wall. Painted EGA grey enamel. Tread rise is 12". 300lb capacity.



TWO STEP WALL-MOUNT LADDER	# Of Steps	Dimensions	Grip Strut®	
			EGA #	Lead Times Days
2	18"x24"	WML	5	



Fixed Vertical & Cage Ladders

Designed specifically for roof and platform access, Fixed Cage Ladders meet all known building codes. A sure way to make your facility safer. These ladders feature a Walk-Thru handrail extending 42" above the top rung to help guide you safely up and down. Cage begins 8' from ground extending to ladder top. Cage flared at bottom for easy access. 300lb capacity. 18" wide steps. Sturdy, 1" diameter wall rungs ensure long life and durability. Meets OSHA standards

# Of Rungs	Overall Length	With Cage Wt. Lbs.	Without Cage Wt. Lbs.	EGA # With Cage	EGA # Without Cage	Lead Times Days
10	12' 8"	187	124	FC10+	FV10	20
12	14' 8"	223	142	FC12	FV12	20
14	16' 8"	261	161	FC14	FV14	20
16	18' 8"	299	181	FC16	FV16	20
18	20' 8"	338	194	FC18	FV18	20
20	22' 8"	368	213	FC20	FV20	20
22	24' 8"	405	-	FC22	N/A	20
24	26' 8"	442	-	FC24	N/A	20

* Other lengths available. Call for prices.

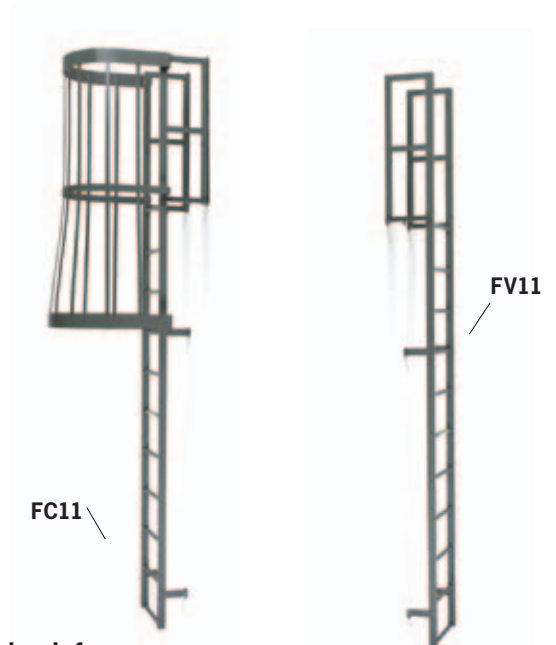

Shipping Info

Starting Zip	Freight Class
53005	All Steps 150 to 300

* NOTE: Stand off platform required every 30'

Options
Floor Mount Legs
Safety cage (for existing ladder)
Security panel
Security gate
Grip Strut Rungs

□ All-Welded Access Stairways ^{60°}

Create strong, reliable access to elevated areas. Sturdy All-Welded stairways ship set-up and ready to go. Simply locate and secure stairway in place with convenient mounting plates at the top and bottom. Mounting plates have pre-punched holes for fasteners. Rigid 1" square tubing. 24" wide steps. Steps are 7" deep with a deeper 14" step at top. Perforated or Grip Strut tread for slip-resistant footing. Meets OSHA standards. 300lb weight capacity.

# Of Steps	Total Rise	Total Run	Overall W x L x H	Wt. Lbs.	Tread Options		Lead Times Days
					EZY Tread®	Grip Strut®	
					EGA #	EGA #	
4	40	35	29x35x70	40	H001	H010	15
5	50	41	29x41x80	50	H002	H011	15
6	60	46	29x46x90	60	H003	H012	15
7	70	52	29x52x100	71	H004	H013	15
8	80	58	29x58x110	82	H005	H014	15
9	90	64	29x64x120	93	H006	H015	15
10	100	70	29x70x130	105	H007	H016	15
11	110	75	29x75x140	122	H008	H017	15
12	120	82	29x82x156	132	H009	H018	15

Shipping Info

Starting Zip	Freight Class
53005	All Steps 150 to 250

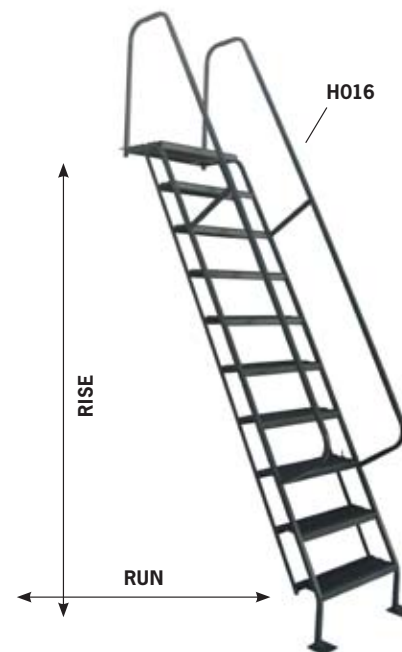

□ Industrial Stairways △ 36.4°

Create strong, reliable access to mezzanines and elevated platforms with our Industrial Stairways. Fully assembled, all-welded construction offers more rigidity than bolt-together designs and eliminates the headaches of do-it-yourself assembly. Safely carries a 500lb moving load. Units have 10" channel stringer for strength and rigidity. 1-1/2" square tubing handrails. Stair treads are a generous 36" wide. Meets OSHA standards.

Grip Strut®



Total Rise	Total Run	# Of Treads	#Of Risers	Wt. Lbs.	EGA #	Lead Times Days
42	47.5	5	6	223	IS42-36	20
49	57.0	6	7	260	IS49-36	20
56	66.5	7	8	309	IS56-36	20
63	76.0	8	9	346	IS63-36	20
70	85.5	9	10	382	IS70-36	20
77	95.0	10	11	419	IS77-36	20
84	104.5	11	12	468	IS84-36	20
91	114.0	12	13	505	IS91-36	20
98	123.5	13	14	541	IS98-36	20
105	133.0	14	15	577	IS105-36	20
112	142.5	15	16	626	IS112-36	20
119	152.0	16	17	663	IS119-36	20



* Other heights available. Call for prices.

* NOTE: Additional handrail available at \$15.00 per linear foot.

□ Industrial Stairways Platform

Grip Strut®



Length	Width	Wt. Lbs.	EGA #	Lead Times Days
36	36	194	PLA3636	20
36	48	236	PLA3648	20
48	48	272	PLA4848	20

Shipping Info

Starting Zip	Freight Class
53005	All Stairways 300



□ One-Step Adjustable Height Platforms

Unique platforms adjust in height by simply twisting the threaded feet for a variety of application and worker requirements. 500lb capacity. Rigid 1" square tubing. Grip Strut tread for slip-resistant footing. Meets OSHA standards.

Grip Strut®



W x D	Adjust. Height	Max. Height	Wt. Lbs.	EGA #	Lead Times Days
24x24	5"-8"	8	30	AHW-L-2424	5
24x36	5"-8"	8	40	AHW-L-2436	5
24x60	5"-8"	8	60	AHW-L-2460	5
24x24	9"-14"	14	30	AHW-H-2424	5
24x36	9"-14"	14	40	AHW-H-2436	5
24x60	9"-14"	14	61	AHW-H-2460	5

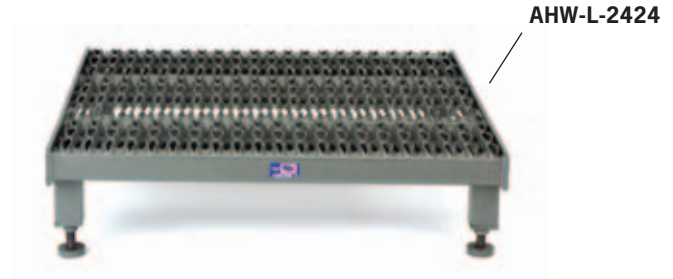

□ Two-Step Access Platforms

Grip Strut®



# of Steps	Step W x D	Overall W x D	Top Step Height	Wt. Lbs.	EGA #	Lead Times Days
2	24x24	25x47	18	60	FHW24	5
2	36x24	37x47	18	80	FHW36	5
2	48x24	48x47	18	90	FHW48	5
2	60x24	61x47	18	120	FHW60	5



□ Steel Step Stools

Platform is 16" W x 14" D. 350lb capacity. Rigid 1" square tubing. Perforated or Solid tread covered with nonslip adhesive rubber for slip-resistant footing. Meets OSHA standards.

EZY Tread®

Anti-Slip Vinyl



Top Step W x D	Overall W x D	Step Height	Wt. Lbs.	EGA #	EGA #	Lead Times Days
16x14	18.5x16.5	10 1/2"	16	PSS	RSS	5



Shipping Info

Starting Zip	Freight Class
28115	All Steps UPS

○ Custom Work Platforms

Our custom platforms allow you to choose the style, step type, height and configuration to perfectly fit your application. Select a single platform, or choose an extension unit which allows you to add 3' to the width of select platform styles. This unit can be at the same height, or function as a step-down area below existing platforms. Multiple options enable you to build a large surface area that surrounds machinery or spans the entire shop, factory or warehouse floor. 500lb capacity. Rigid 1-1/4" diameter tubing. 36" wide steps. Steps are 7" deep with a deeper 36" platform at top. Grip Strut tread for slip-resistant footing. Meets OSHA standards.



CW0-27-0-3 w/ CW7-27-3-3
Style 7 and Style 0



CW0-27-0-3
Style 0



CW1-27-3-3
Style 1



CW2-27-3-3
Style 2



CW3-27-3-3
Style 3



CW4-27-3-3
Style 4



CW5-27-3-3
Style 5



CW6-27-3-3
Style 6



CW7-27-3-3
Style 7



CW8-27-3-3
Style 8



CW9-27-3-3
Style 9

Style	# of Steps*	Dimensions (inches)						EGA #	Lead Time Days	Weight
		OAW	OAL	OAH	PW	PL	PH			
0	n/a	39	39	21	35	39	21	CW0-21-0-3	5	100
0	n/a	39	39	27	35	39	27	CW0-27-0-3	5	115
0	n/a	39	39	33	35	39	33	CW0-33-0-3	5	115
0	n/a	39	39	39	35	39	39	CW0-39-0-3	5	115
0	n/a	39	39	45	35	39	45	CW0-45-0-3	5	115
1	2	39	48	21	35	39	21	CW1-21-2-3	5	120
1	2	39	86	21	35	77	21	CW1-21-2-6	5	187
1	3	39	57	33	35	39	33	CW1-33-3-3	5	140
1	3	39	95	33	35	77	33	CW1-33-3-6	5	230
2	2	39	48	60	35	39	21	CW2-21-2-3	5	150
2	2	39	86	60	35	77	21	CW2-21-2-6	5	235
3	2	39	57	60	35	39	21	CW3-21-2-3	5	150
3	2	39	95	60	35	77	21	CW3-21-2-6	5	225
4	2	39	48	60	35	39	21	CW4-21-2-3	5	145
4	2	39	86	60	35	77	21	CW4-21-2-6	5	225
5	3	39	57	66	35	39	27	CW5-27-3-3	5	185
5	3	39	95	66	35	77	27	CW5-27-3-6	5	285
5	3	39	57	72	35	39	33	CW5-33-3-3	5	185
5	3	39	95	72	35	77	33	CW5-33-3-6	5	290
6	3	39	75	72	35	39	33	CW6-33-3-3	5	207
6	3	39	113	72	35	77	33	CW6-33-3-6	5	290
6	4	39	93	84	35	39	45	CW6-45-4-3	5	245
6	4	39	131	84	35	77	45	CW6-45-4-6	5	335
7	3	39	57	66	35	39	27	CW7-27-3-3	5	180
7	3	39	95	66	35	77	27	CW7-27-3-6	5	260
7	3	39	57	72	35	39	33	CW7-33-3-3	5	175
7	3	39	95	72	35	77	33	CW7-33-3-6	5	265
7	4	39	66	84	35	39	45	CW7-45-4-3	5	200
7	4	39	104	84	35	77	45	CW7-45-4-6	5	290
8	4	39	66	78	35	39	39	CW8-39-4-3	5	205
8	4	39	104	78	35	77	39	CW8-39-4-6	5	310
8	4	39	66	84	35	39	45	CW8-45-4-3	5	205
8	4	39	104	84	35	77	45	CW8-45-4-6	5	310
9	3	39	75	72	35	39	33	CW9-33-3-3	5	235
9	3	39	113	72	35	77	33	CW9-33-3-6	5	340

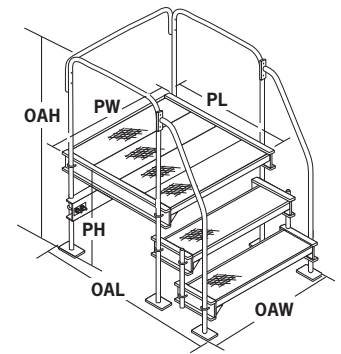

Chart Key	
OAW	= Overall Width
OAL	= Overall Length
OAH	= Overall Height
PW	= Platform Width
PL	= Platform Length
PH	= Platform Height

Shipping Info

Starting Zip	Freight Class
28115	70

* - # of steps is # of risers to top of platform. # of step treads is actually 1 less than riser.

○ Pallet Rack Bay Dividers

Easily organize pallet racks. Can be installed temporarily or permanently with prepunched mounting holes. Made of 1" diameter tubing for durable performance. Painted EGA yellow. Fits any 3" rack beam.

Dimensions	EGA #	Weight Lbs.	Lead Times Days
36"x54"BD	BD54-36	9.5	10
42"x54"BD	BD54-42	10.5	10
48"x54"BD	BD54-48	11.5	10

Shipping Info

Starting Zip	Freight Class
53005	70



Swing Gates

Swing gates are an easy, inexpensive solution to enclosing handrail openings. Available in two sizes which are adjustable to fit almost any opening. Gate opens a full 90 degrees. Hardware for multiple mounting options included with each gate. All models are self actuated with a heavy duty stainless steel spring. Available in yellow powder coat, hot dipped galvanized or stainless steel.

Description	Fits Opening	Wt. Lbs.	EGA #	Lead Times Days
Self Closing Gate-narrow-Yellow Powder Coat	16"-26"	36	SCG-N-Y	5
Self Closing Gate-narrow-Hot Dipped Galvanized	16"-26"	37	SCG-N-G	15
Self Closing Gate-narrow-Stainless Steel	16"-26"	36	SCG-N-S	15
Self Closing Gate-wide-Yellow Powder Coat	24"-40"	38	SCG-W-Y	5
Self Closing Gate-wide-Hot Dipped Galvanized	24"-40"	39	SCG-W-G	15
Self Closing Gate-wide-Stainless Steel	24"-40"	38	SCG-W-S	15

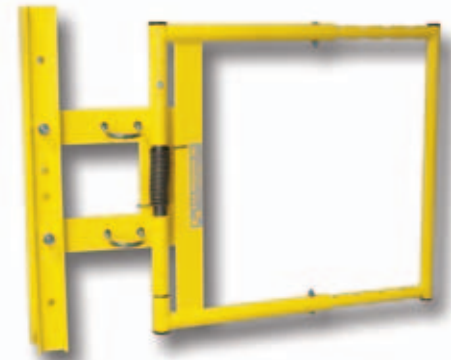

Shipping Info

Starting Zip	Freight Class
53005	UPS Ground

Die Shelves for Pallet Rack Beams

Designed for standard 1-5/8" step beams, EGA's Die Shelves provide a solid sheet steel deck for increased utility of existing pallet rack locations and durability. The die shelves are available with a low to high capacity of 2,000 to 6,000 pounds. Options include waterfall edges, back stop with lip up corners, colors (standard is grey enamel finish), and custom designs available.

D"xW"	2,000 Lbs. Capacity		4,000 Lbs. Capacity		6,000 Lbs. Capacity		Lead Times Days
	EGA #	Wt. Lb.	EGA #	Wt. Lb.	EGA #	Wt. Lb.	
36x48	2DS 3648	62	4DS 3648	78	6DS 3648	101	10
36x60	2DS 3660	71	4DS 3660	87	6DS 3660	110	10
36x72	2DS 3672	80	4DS 3672	96	6DS 3672	119	10
44x48	2DS 4448	76	4DS 4448	95	6DS 4448	125	10
44x60	2DS 4460	87	4DS 4460	106	6DS 4460	136	10
44x72	2DS 4472	99	4DS 4472	118	6DS 4472	178	10

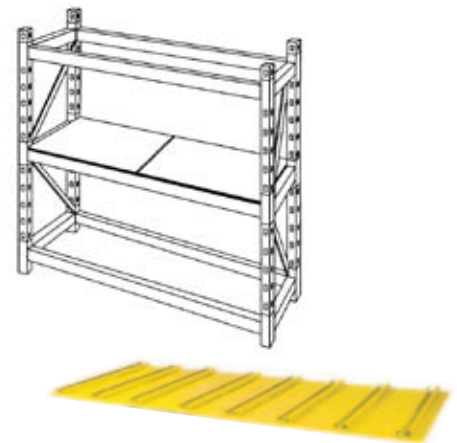

Shipping Info

Starting Zip	Freight Class
53005	70

Partitions

Use EGA's mesh partitions to build enclosures without sacrificing visibility or rerouting existing air ducts, piping and lighting systems. Expanded metal mesh allows pass-through holes without unraveling. Plus, smooth expanded metal mesh won't catch clothing or cause scratches. Choose from a variety of panel, door and hardware configurations to meet your needs.

Standard Panels

Standard panel widths are 1 - 5 feet in three standard heights of 7, 8 and 10 feet. For maximum security at an affordable price, use panels 5 feet wide and 7 feet high. The large panels cost less per linear foot than any other known system and provide almost unlimited configurations for safety, security, convenience and privacy. Best of all, your crew can put them up quickly, with or without power tools.

Two types of doors

Single sliding door available in standard 3', 4', 5', and 6' widths for partitions 7', 8', and 10' high. Service window available. Single swinging door available in standard 3' and 4' widths for partitions 7', 8', and 10' high. Service window available.

Two Locking Systems

For hinged or slide gate doors. Standard is pick-proof, fully reversible multi-lock with high impact die cast aluminum case, brass cylinder, tongues and recessed knurled finger operating knob. Five pin, 1" standard cylinder secured by nut inside lock. Keys can be; door unique, keyed alike, or master keyed. Rugged padlock-type has welded hasp. Security opening accommodates various types of locks.

Industry's best shipping protection Palletized, banded, shipping unit eliminates handling damage and lost parts.

Features

- Constructed of 13-gauge expanded metal in 1 1/2" diamonds.
- Least expensive system to erect because unique fasteners permit use of power tools.
- Lower cost because corner posts are unnecessary.
- Lowest freight costs due to extremely light weight despite unusual strength.
- Palletized shipping minimizes freight damage and eliminates missing parts.

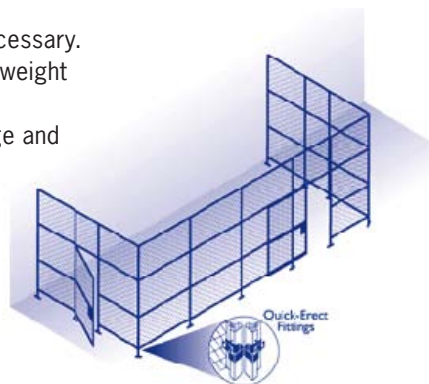

- Fully reversible: both sides of mesh are finished thanks to special perimeter design.
- No burrs: surface is brushed and blasted.
- No unraveling when pass-through cuts are made.
- EZY and true vertical alignment with adjustable floor sockets.
- Solid panel or wainscot, top or bottom, integral with panel not merely "tacked on".

Plus

- Wide range of sizes and configurations.
- Doors have mortise-type cylinder locks operated by key or optional padlock hasp.
- Changeable configurations by rearranging, adding or removing units.
- Special colors available.
- Doors keyed individually, alike or master keyed.
- Super-durable, gray enamel finish is standard.

Accessories

1. Ceiling for all enclosures provides maximum security.
2. Extension panels to increase enclosure height up to 20'. Each panel spans two bottom panels.
3. Sliding door, described at left.
4. Hinged door, described at left.
5. Slide-up service windows. Standard 3' 10" x 18" opening with optional 12' steel shelf.
6. Wainscotting. 18 gauge sheet steel, half or full panels.
7. Cutouts will not unravel thanks to our specially fabricated expanded metal.
8. Vari-panel is the most economical solution to incremental widths or non-square dimensions.



How to Order

EGA standard size wall panels in widths of 1 ft., 2 ft., 3 ft., 4 ft., and 5 ft., greatly reduce the need for special width panels. However, if required, EGA can produce special sizes for an additional charge.

1. Make a rough floor plan of the area to be enclosed.
Note overall inside dimensions on the drawing.
2. Select type of partition (SG-1000, SG-2000, SG-3000).
3. Select height of partition (7'0", 8'0", and 10'0" standard).
4. Indicate on drawing the location and size of all doors and service windows:
 - a) show direction doors swing or slide.
 - b) show key side.
 - c) indicate whether locks are to be keyed alike, different, master keyed or padlock attachment.
5. Location of reinforcing posts (every 20' recommended for 7' and 8' high panels; every 10' for 10' high panels).
6. Color of paint if other than standard gray enamel.

Wall panels

Identical both sides. Price includes all necessary hardware and extra-high adjustable cast aluminum floor sockets. Floor anchors supplied by installer.

Solid panels

18 gauge metal replaces mesh. Specify solid panels when ordering wall panels or doors.

Vari-panel

This adjustable panel is use when an enclosure can't be completed with a standard panel. Simply slide to appropriate width and bolt together. Kit includes... (A) top and bottom perimeter bars, (B) two 7" wide panels, (C) panels are 7', 8', or 10' high, (D) bolts and washers, (E) sheet metal screws.

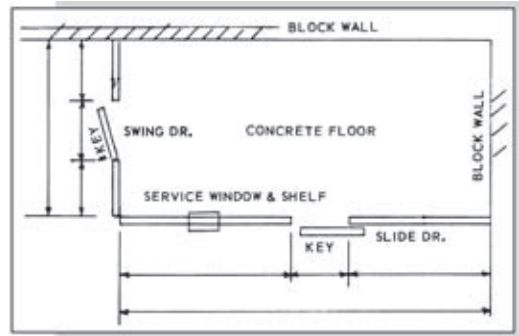
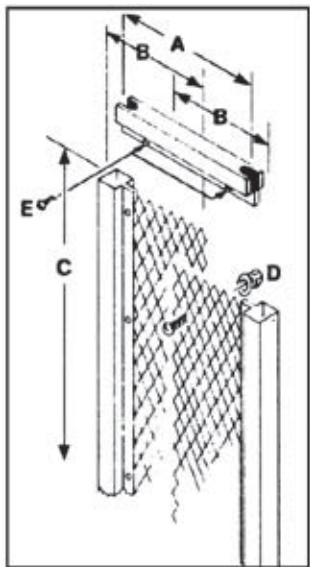

Whenever possible, furnish drawings or simple sketches such as the one shown here.

STANDARD WALL PANEL	Width	7 Ft. Height		8 Ft. Height		10 Ft. Height	
		EGA #	Wt. Lb.	EGA #	Wt. Lb.	EGA #	Wt. Lb.
	5'	SP75	46	SP85	51	SP105	64
	4'	SP74	37	SP84	40	SP104	51
	3'	SP73	28	SP83	30	SP103	38
	2'	SP72	18	SP82	20	SP102	27
	1'	SP71	9	SP81	10	SP101	13

ODD SIZE PANEL	Width	7 Ft. Height		8 Ft. Height		10 Ft. Height	
		EGA #	Wt. Lb.	EGA #	Wt. Lb.	EGA #	Wt. Lb.
	4'-5'	OP74	41	OP84	45	OP104	58
	3'-4'	OP73	33	OP83	35	OP103	44
	2'-3'	OP72	23	OP82	25	OP102	32
	1'-2'	OP71	13	OP81	05	OP101	19
	4"-1'	OP70	7	OP80	10	OP100	12

Any width available in 1/4" increments

*VARI-PANEL	Width	7 Ft. Height		8 Ft. Height		10 Ft. Height	
		EGA #	Wt. Lb.	EGA #	Wt. Lb.	EGA #	Wt. Lb.
	Adj. 3"-1'	VP7	9	VP8	10	VP10	13

Adjustable width panels from 3" to 1'



TYPE SG-2000



TYPE SG-3000



Quick-Erect Fittings
Die formed to assure ease of assembly and flexibility in moving or re-arranging configuration.



Bottom Wainscot: SG2000 Add \$8 per lineal foot to wall, panel or door price.
Complete Solid: SG3000 Add \$15 per lineal foot to 7' or 8' high wall, panel or door price.
 Add \$16 per lineal foot to 10' high wall, panel or door price.

Width	7 Ft. Height		8 Ft. Height		10 Ft. Height	
	EGA #	Wt. Lb.	EGA #	Wt. Lb.	EGA #	Wt. Lb.
Hinged Door (With Transom)						
3'	DH73	43	DH83	45	DH103	53
4'	DH74	52	DH84	55	DH104	66
Sliding Door (Standard)						
3'	DS73	58	DS83	60	DS103	68
4'	DS74	67	DS84	70	DS104	81
5'	DS75	76	DS85	80	DS105	94
6'	DS76	85	DS86	90	DS106	106
Sliding Door (Full Height Option)						
5'	DSH75	76	DSH85	80	DSH105	94
6'	DSH76	85	DSH86	90	DSH106	106
8'	DSH78	104	DSH88	110	DSH108	132
10'	DSH710	122	DSH810	113	DSH1010	157

7 Ft. Height		8 Ft. Height		10 Ft. Height	
EGA #	Wt. Lb.	EGA #	Wt. Lb.	EGA #	Wt. Lb.
Line Post (Standard)					
LP7	14	LP8	16	LP10	20
Line Post (Extra Heavy)					
LPE7	18	LPE8	20	LPE10	25
Adjustable Corner Post (Non 90° Intersections)					
LPA7	16	LPA8	17	LPA10	21

CEILING OR WALL EXTENSION PANELS

	5 Ft.W	4 Ft.W	3 Ft.W	2 Ft.W	1 Ft.W
10 Ft.H	-	-	-	-	-
9 Ft.H	-	-	-	-	-
8 Ft.H	-	-	-	-	-
7 Ft.H	-	-	-	-	-
6 Ft.H	-	-	-	-	-
5 Ft.H	-	-	-	-	-
4 Ft.H	-	-	-	-	-
3 Ft.H	-	-	-	-	-
2 Ft.H	-	-	-	-	-
1 Ft.H	-	-	-	-	-

CORNER HARDWARE

Model	Wt. Lb.
CH	2
TH	3

Shipping Info

Starting Zip	Freight Class
53005	150

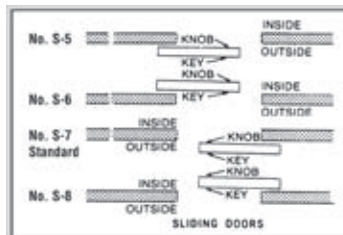
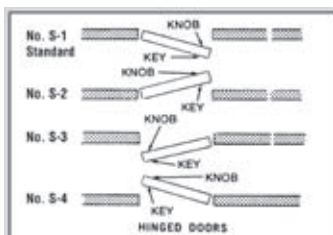

Doors

Includes all necessary hardware, floorplate, and mortised tumbler lock with 2 keys. Door opening 2 1/2" less than nominal door width. Standard opening height is 6' 6" for 7' high doors and 7'3" for 8' and 10' high doors.

Hinged Door

Standard door opens out of room and has 3 butt hinges on left side when looking at door from outside. Specify different arrangements if required...provided at no additional charge.

Sliding Door (standard)

Standard door is outside room and slides to the right when looking at the door from outside. Specify different arrangements if required... provided at no additional charge. Includes separate mounted floor door guide and door frame protector.

Sliding Door (full height opening)

Clear open height is 6" less than overall height.

STRUCTURAL REQUIREMENTS

Line Post (standard)

Required for every 20' run of 7' and 8' high partition without corners or doors. Required for every 10' run of 10' high partition without corners or doors.

Line Post (extra heavy)

Use for extra rigidity on walls or in heavy traffic areas.

Adjustable Corner Post

Required for corners other than 90 degree.

Corner Hardware

CH required for each 90 degree corner in system.

TH required for joining wall panels in a "T" configuration.

Ceiling or Wall Extension Panels

Provides maximum security. Odd size panel, use larger size + \$12.

ORDER INSTRUCTIONS:

Use Model# CE HW

Key: H is height; W is width.

Panels can be oriented either way.

Example: CE 105 is 10' high x 5' wide.

Panel weight is 1.3 lbs. per sq. ft.

Ceiling Truss – Use when ceiling span exceeds 10 ft.

Accessories

***PADLOCK LUGS** – Deduct \$19 instead of mortised tumbler lock on all doors. Specify when ordering.

***KEYED ALIKE (multiple doors)** – No charge.

***MASTER KEYED (multiple doors)** – Add \$48 for each locking system.

SERVICE WINDOW UNIT – 32" opening in 3' and wider wall panels or doors. Add \$244 to wall panel or door price.

SHELF – 8" wide shelf centered on window. Add \$33 to service window.

Post Protectors

Post protectors help prevent serious personal injury and damage to rack posts, shelving corners, partitions, overhead door track bases and more. Inexpensive and easy to install, post protectors are one of the least expensive ways of reducing costs related to damaged racks.

Features

- Protects materials as well as shelves and racks.
- Sizes available for both 3" and 4" diameter columns.
- Several heights to accommodate various shelf, rack and column designs.
- Fabricated from rugged 1/4" steel plate for durability.

Plus

- Low cost way to reduce expensive damage.
- Quick, simple installation.
- The original and still the best design.
- Finished in EGA safety yellow.
- Ships UPS. Shipped from factory stock approximately 5 working days. Choose from a variety of sizes developed to accommodate virtually every shelf and rack column.

Easy to install

- Simply position Post Protectors around rack posts, shelving corners, partitioning or track base. Drill proper size holes in floor. Anchor with 1/2" fasteners (not provided)

Your Column Size	A Overall Height	B Plate Width	C Plate Depth	D Column Opening	E Base Plate Opening	Wt.	EGA #	Lead Times Days
3	8	7 5/8	6	4	3 3/8	7	5208	5
3	12	7 5/8	6	4	3 3/8	10	5212	5
3	18	7 5/8	6	4	3 3/8	14	5218	5
3	24	7 5/8	6	4	3 3/8	19	5224	5
3	36	7 5/8	6	4	3 3/8	28	5236	5
4	8	7 5/8	6	5	4 3/8	8	6208	5
4	12	7 5/8	6	5	4 3/8	11	6212	5
4	18	7 5/8	6	5	4 3/8	16	6218	5
4	24	7 5/8	6	5	4 3/8	21	6224	5
4	36	7 5/8	6	5	4 3/8	32	6236	5

dimensions are in inches

Shipping Info: Wisconsin or North Carolina

Starting Zip	Freight Class
28115	All Post Protectors 70

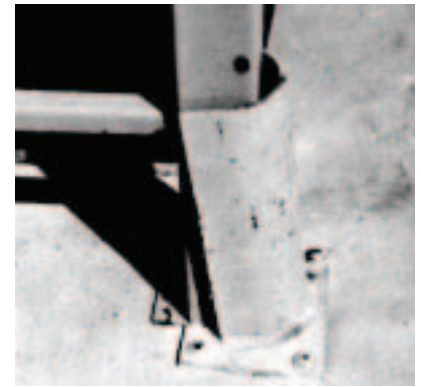

Proof Positive

This EGA Post Protector (Fig 1.) withstood three rammings from an overloaded, 2,500-pound lift truck in a large Midwest manufacturing facility.

A 12-inch post protector was secured by a 3/8" x 3" Rawl plugs for the test. The rack and its contents were undisturbed.

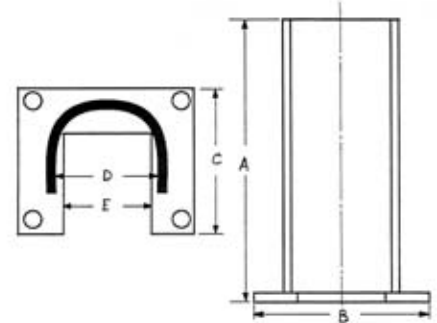

POST PROTECTORS



Cylinder Cabinets

Store common fuel and welding gas cylinders indoors or outdoors in cabinets that meet OSHA standards. Cabinets provide organized storage, secure from unauthorized use or tampering.

Features

- Cabinets are constructed of 13 gauge expanded metal in 1 1/2" diamonds.
- Shipped KNOCKED DOWN in a protective box.
- EZY-ERECT hardware speeds erection, reducing manpower requirements.
- HCC models for horizontal storage of 4 to 16 tanks weighing up to 43 Lbs. each.
- VCC models for upright storage of cylinders. One or two labeled compartments store empty and/or full cylinders.

Plus

- Frame provides super strength, yet is lightweight.
- Quick, visual inventory control.
- Painted safety yellow (Indoor paint standard).
- Identification sign and NO SMOKING decals provided per regulations.

Options

- Pre-assembled or fully welded units.
- Custom Cabinets? Send us your RFQ.



W	D	H+	Cylinder Capacity	Shipping Weight	EGA #	Lead Times Days
30"	38"	42"	4	147	HCC4	5
30"	38"	72"	8	250	HCC8	5
45"	38"	72"	12	300	HCC12	5
60"	38"	72"	16	300	HCC16	5
30"	38"	72"	1 compartment	176	VCC10	5
60"	38"	72"	2 compartment	309	VCC20	5

Shipping Info: Wisconsin

Starting Zip	Freight Class
53005	Knocked down 85

Portable Stacking Racks

Portable Stacking Racks are known for their versatility - ours are no exception. Whether it's storage, handling, or transporting, EGA Portable Stacking Racks perform where and when they are needed. Racks not in use can be broken down for convenient, compact storage freeing up floor space normally occupied by bulky, permanent rack systems. Materials can now move through your entire production process...all on the same rack.

Stacking racks give you the best of both worlds: weight load capacities rivaling wood pallets...combined with the positive stacking and product protection only plug/post joint racks can deliver. EGA has designed portable stacking racks for a variety of applications including: textiles, wire coils, automotive parts, tires, and more. Available in open frame, wood, steel, welded wire mesh or perforated steel decks.

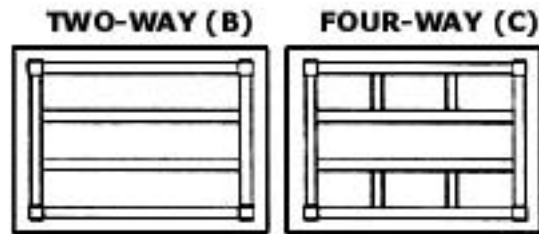
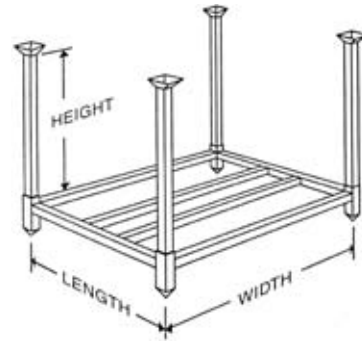

Features

- Stackable.
- Welded tubular and structural steel construction provides reliable load carrying strength.
- Standard duty 2,000 lbs. or heavy duty 4,000 lbs. capacity.
- Standard target is 4" square tube and mounted on removable stacking posts.
- Standard end or side frames is a steel framework of horizontal and vertical angles welded between pairs of posts.
- Standard post is 1.5" square tube on 2000 lbs. capacity units and 2.17" square tube on 4000 lbs. units.
- Standard plug is base mounted.
- Designed for fork lift handling with Two-Way, Four-Way, or Full Four-Way accessibility.
- Select from a broad range of deck surfaces (open frame, wood, steel, welded wire mesh, or perforated sheet steel).
- Standard sizes change in 6" increments (custom made to any size).
- Store heavy or irregular shaped pieces that can not be stacked on top of each other.
- Virtually unlimited configurations possible due to a wide range of bases, sides, and ends.
- Custom engineering available for over-the-road shipping, product protection, etc.

Plus

- Store compactly when not in use.
- Free up valuable floor space.
- Return more empties in less space.
- Flexible plant layout possible because these racks are portable.
- Change size, shape and location of storage areas as space or work load dictates.
- Use for intra-plant as well as interplant materials movement.
- Coil racks, fixed posts, interstacking with existing units, and nestable racks.

Options

- Floor skid runners for unit conveyability.
- Fork stirrups or pockets to prevent shifting of racks on fork tines.
- Custom design? Send your RFQ.



Shipping Info: Wisconsin or North Carolina

Starting Zip	Freight Class
53005 or 28115	70

FOB EGA WI & NC

CLASS 150

INDUSTRIAL ROLLING LADDER MOBILE WORK PLATFORMS FIXED LADDERS STATIONARY PLATFORMS SECURITY STORAGE



Custom Engineered Returnable Racks

Caring about workers and the environment.

When this tier 1 supplier needed a transport rack for their rear-suspension assemblies, they were precise. The racks needed to be both returnable and ergonomically designed to minimize worker fatigue. Working with the supplier, EGA designed and built custom stackable racks that allow random loading at the supplier and permit easy random unloading at the automotive assembly line. And because all painted surfaces are protected by the racks during transit, hard-to-dispose-of-packaging waste was eliminated.



Why Custom Engineered Returnable Racks?

Manufacturers have had to settle for something less than the best way to store and transport their products. They've had to use packaging, pallets and racks that left their products every which way AND loose. The results have been needless waste of space, product, labor and material dollars.

EGA provides you with the better way. Our Custom Engineered Returnable Racks incorporate the features and characteristics of your products and processes into rack design that saves you space, product, labor and money.

Using EGA's Custom Engineered Returnable Racks, you change the size, shape and location of staging and inventory areas. And by leaving material on Returnable Racks, you easily move work-in-process around the plant, or between plants, to better meet scheduling or seasonal needs. Then by using a design feature that allows you to fold them when not in use, you compactly store or return empty Returnable Racks to free up floor or trailer space.



Don't settle for anything less than the best way to store and transport your product. Get the material handling solution that truly meets your needs, again and again. EGA Custom Engineered Returnable Racks.

Benefits of Returnable Rack

Send your custom specifications and we will return a quote within 2-3 business days.



Bulk Containers

Visualtainers

No more looking up at racks and guessing at what's inside. Visualtainers™ let you actually see your materials inventory. Critical to today's JIT production processes, Visualtainers help you keep a high volume of parts close to the production line - accessible and easy to transport. These versatile units can be stacked six high at a rated capacity of 2,000 lbs. or 4,000 lbs. Available in both standard and custom designs to meet your special applications.

Solid-Sided

Solid-Sided dunnage containers are designed to store small items or granular materials and are available in corrugated or flat steel sides in gauges seven through 16. Standard sizes are offered in height increments of two inches; floor clearance ranges from four to 12 inches. Top flanges can be turned in or out depending on the application.

Send your custom specifications and We will return standard quotes within one business day. More complex or higher quantity quotes may take 2-3 business days.

Shipping Info: Wisconsin or North Carolina

Starting Zip	Freight Class
53005 or 28115	150

VISUALTAINER



BULK CONTAINER



Visualtainers™ Information Requirements	Standard Sizes		
	W"	L"	H"
Load Size (O.D.) ____ "L ____ "W ____ "H			
Load Wt. ____ lbs.	32	40	24
____ 2 way ____ 4 way (Entry)	32	40	30
Gates ____ 1 ____ 2 ____ None (Locations)	32	48	30
	36	48	24
Welded Wire: 2"x2"x4GA	40	48	24
2"x4"x4GA	40	48	30
4"x4"x4GA	48	48	24
Please describe application in detail.	48	48	30
FOB EGA WI & NC		CLASS 150	

Trucks/Dollies/Carts

EGA Steel Trucks, Dollies and Carts are ideal for use in stock rooms, shipping and receiving, production and warehouse operations. Standard and special features on every truck and cart make these a smart choice for any application.

Features

- 1,000, 2,500, and 3,200 lbs. capacities.
- All-welded construction for long service life.
- 14 gauge deck and shelving standard.
- Two rigid and two swivel casters standard in 5", 6" and 8" sizes.



Plus

- Sturdy steel decking.
- Rigid frame.
- Rugged, easy rolling casters.
- Sizes and types for every use.
- Easily replaceable ball bearing casters.
- Gray enamel finish.



Options

- Four swivel casters.
- 2" lips up or down on shelves.
- Colors.
- Handles 1 or both ends.
- Custom design - Send your RFQ.



Replacement Casters and Options For Carts

Description
Carts Lips Down
1000 Lb. Capabilities
5" Hard Rubber Caster
2000 Lb. Capabilities
6" Heavy Duty Plastic
3200 Lb. Capabilities
8" Heavy Duty Phenolic
3200 Lb. Capabilities
8" Pneumatic

Replacement Caster for Carts

Description
1,000 Lb. Capabilities
5" Hard Rubber Casters
2,500 Lb. Capabilities
6" Heavy Duty Plastic
3,200 Lb. Capabilities
8" Heavy Duty Phenolic
3,200 Lb. Capabilities
8" Pneumatic

Shipping Info: North Carolina

Starting Zip	Freight Class
28115	150

	W"	L"	Wt. Lbs.	1,000 Lbs. Capacity	Lead Times Days
PLATFORM TRUCKS	24	36	65	C1-2436-1R	10
	24	48	92	C1-2448-1R	10
	30	48	86	C1-3048-1R	10
	30	60	115	C1-3060-1R	10
Deck Ht.				7 1/2"	

Shipping Info: North Carolina

Starting Zip	Freight Class
28115	70

	W"	L"	Wt. Lbs.	1,000 Lbs. Capacity	Lead Times Days
SHOP CARTS	24	36	91	C2-2436-1	10
	24	48	112	C2-2448-1	10
	30	48	128	C2-3048-1	10
	30	60	153	C2-3060-1	10
Top Shelf Height				31"	
Overall Height				41"	

	W"	L"	Wt. Lbs.	1,000 Lbs. Capacity	Lead Times Days
STEEL DOLLIES	24	36	52	C1-2436-1	10
	24	48	79	C1-2448-1	10
	30	48	86	C1-3048-1	10
	30	60	101	C1-3060-1	10
Deck Ht.				7 1/2"	

Shipping Info: North Carolina

Starting Zip	Freight Class
28115	70

Additional Capacity

- 2,500 lbs. capacity add \$78 to 1,000 lbs. price and 1 1/4" to listed heights.
- 3,200 lbs. capacity add \$106 to 1,000 lbs. price and 3 1/2" to listed heights.

3 Shelf Trucks				4 Shelf Trucks		5 Shelf Trucks		
W"	L"	Wt. Lbs.	1,000 Lbs. Capacity	Wt. Lbs.	1,000 Lbs. Capacity	Wt. Lbs.	1,000 Lbs. Capacity	Lead Times Days
24	36	98	C3-2436-1	129	C4-2436-1	232	C5-2436-1	10
24	48	122	C3-2448-1	161	C4-2448-1	273	C5-2448-1	10
30	48	157	C3-3048-1	202	C4-3048-1	313	C5-3048-1	10
30	60	196	C3-3060-1	252	C4-3060-1	363	C5-3060-1	10
Top Shelf & OA Ht.			37"		51"		65"	